

INTERLINE

SWIMMING POOL ROBOT WALKING CATFISH



ENGLISH

ver 20-01



Robotic pool cleaner Walking Catfish

Congratulations on the purchase of your new Interline robotic pool cleaner Walking Catfish. It is a powerful autonomous robot delivered ready to use. Ideal for pools of all sizes and in all forms. This robot comes with an easy accessible debris basket along with floating rotary coupling which limits cable entanglement.

Please check the package to make sure that all parts are ready to be installed.

We recommend that you check the connections of the cables from the cleaner to the floating rotary coupling plug (chapter 4). If any parts are missing or damaged, please contact Interline directly on www.interline-products.com

Table of contents

01 Product features	p04.
02 Warnings and Safety information	p04.
03 Package contents	p05.
04 Start-up	p06.
05 Climbing walls	p08.
06 Cleaning the filter basket	p09.
07 Cleaning the impeller	p10.
08 Indicator Lights / LED	p11.
09 Troubleshooting	p12.
10 Spare parts list	p15.
11 Spare parts drawing	p17.

01 Product features

Maximum Depth: 2,5m

Maximum size of the pool: 10m x 5m

Input current: 100-130V AC / 200-230V AC

Output current: <24VDC

02 !! Warnings and Safety information !!

- 2.1 Please refer to the rules of your country regarding swimming pool safety.
- 2.2 Place the power transformer at least 3.5 m from the pool.
- 2.3 If the cables delivered are damaged, they must be replaced by the manufacturer, a service centre approved by the manufacturer or a qualified person to avoid any risk.
- 2.4 Please make sure that your electrical system is well protected by a 30mA ground fault circuit interrupter (GFCI)
- 2.5 Do not use extension cord.
- 2.6 This unit must only be used with the supplied transformer.
- 2.7 This appliance can be used by children aged from 8 years and above and persons with reduced physical, sensory or mental capabilities or lack of experience and knowledge if they have been given supervision or instruction concerning use of the appliance in a safe way and understand the hazards involved.
Children shall not play with the appliance.
Cleaning and user maintenance shall not be made by children without supervision.
- 2.8 Keep the power transformer away from moisture.
- 2.9 Do not use the robot out of the water.
- 2.10 Make sure that the transformer is disconnected before performing maintenance on the robot.
- 2.11 Don't use any damaged power cable or cord.
- 2.12 Do not use the robot if people are in the pool.
- 2.13 Do not use the swimming pool when the cleaner is in the pool.
- 2.14 Remove the robotic cleaner from the swimming pool when not in use
- 2.15 The use of the robot should be in a pool whose temperature is between 5 and 36°C.
- 2.16 Make sure to maintain a pH close to 7.2 for optimal performance, especially on the ability to climb walls.
- 2.17 Do not use the robot if you have a counter-current swimming device working.

03 Package contents

1. Robotic pool cleaner Walking Catfish
2. Power transformer control box
3. Long cord
4. No-twist Floating device with rotary coupling
5. Sample of fine filter



QUICK FACTS

- Our robots are designed to facilitate the maintenance of your pool. However, they are not intended to clean a pool full of algae and leaves (ex: end of winter period). In this case you must: use the leaf skimmer, clean the filter and put back on the filter and the pump.
- A tile coating leads to faster wear of the brushes and belts. Please check these regularly.



- To remove the cleaner from your pool, lift the cable slowly and gently until you can grab it by the handle. Use the handle to fully pull out the cleaner
- In order to access the filter basket, place hands as shown in picture. Push with thumbs to unlock lid.

04 Start-up



4.1 Unscrew the cap next to the switch.



4.2 Insert the end of the floating cable into the socket. Be careful with the direction of the plug.



4.3 Insert the end of the floating cable from the transformer into the black "POWER" socket. Be careful with the direction of the plug.



4.4 Slide the cap to contact the plug of the floating swivel union.



4.5 Tighten the black nut on the floating rotary coupling by hand.



4.6 Repeat the operation on the blue side marked "POOL ROBOT" with the cable from the robot.

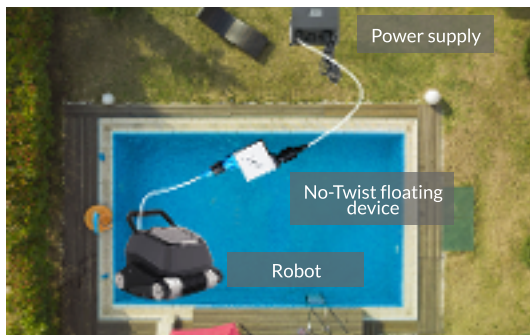

4.7 Place your power box to a midpoint between the two ends of your pool and at least 3.50 m from the edge of the pool.



4.8 Place the robot in your pool and wait until it is completely submerged. If necessary, help it to sink manually.



4.9 Screw the nut of the floating cable firmly. Press the switch on the side of the transformer to turn it on. A blue light appears.



4.10 Press the on/off button located above the transformer to turn on the robot. A red light appears. At the end of the cleaning cycle the red light will turn off.



- 4.11 For optimal performance, place your robot in the pool at the furthest possible location from the power source.

This is the appropriate length of the cable so that the robot can reach all of your pool.

Limit the length of cable in the pool to the bare minimum, and place the surplus outside the pool.

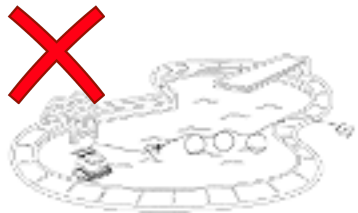

- 4.12 To turn off your robot, press the power button and hold for 3 seconds. Alternatively, you can also press the switch located on the side of the box, under blue light.

- 4.13 Do not remove your robot out of water immediately after the end of its cleaning cycle so as not to cause a temperature shock.

- 4.14 When the cleaner is no longer used for an extended period, screw on the protective cap on the power supply and store your robot indoors.

05 Climbing Walls

In order to be efficient while cleaning the waterline, the robot is designed to climb up the waterline with the orientation that offers the most effective brushing.

It is therefore normal to see it climb to the waterline only by the side with the handle.

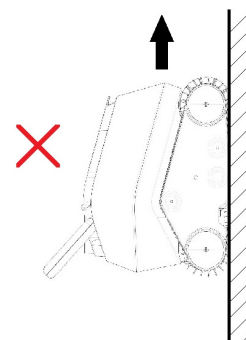
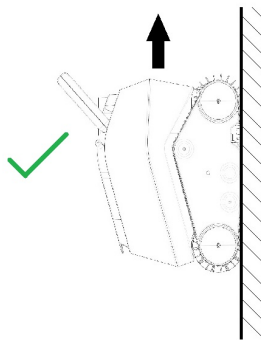

06 Cleaning the filter basket



6.1 In order to access the filter basket, place hands as shown in picture. Push upward 5 cm with thumbs to unlock cover.



6.2 Use both hands to lift the basket with the handles on the sides of the basket



6.3 Open the lid of the basket by pulling the tab on the front of the basket and empty content.

6.4 Empty the debris inside the basket. Use a jet of water to rinse the faces inside and outside the basket filter panels. Also inspect and clean the inside and outside of the robot.



6.5 Once cleaned, replace the basket in the robot. If the basket is not properly aligned, it is not possible to close the cover of the cleaner.

6.6 Press down the handles to lock your basket

07 Cleaning the impeller

Some debris can clog or be wrapped around the impeller of the pump. By force, these debris can hinder the proper functioning of the robot or even damage the engine.

Regular visual inspection is part of the normal maintenance of the robot.



7.1. Use a flat screwdriver to remove the protective grille.



7.2 Clean the impeller.
7.3 Replace the grill guard.

08 Indicator lights / LED

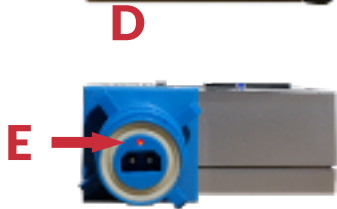
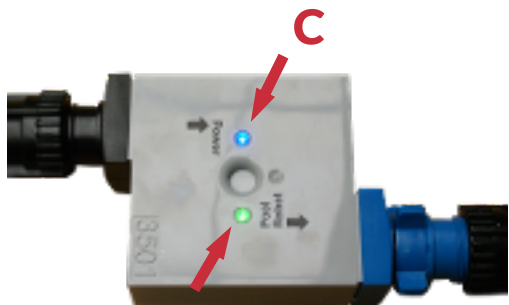
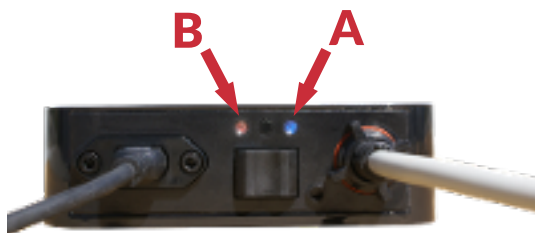

INDICATOR LIGHT / LED	MEANING / DIAGNOSIS
A	When the power supply is plugged into wall outlet and toggle switch is pressed towards "ON", this blue light must remain on to indicate that the power supply is operating normally. Otherwise check if the wall outlet has power or replace the transformer.
B	It is a timer indicator. This red light will light up during the 2 hour cleaning cycle.
C	This blue light turns on when the floating cord between the transformer and the No-Twist float with swivel union is properly connected and you have turned on the robot. It indicates that the current is reaching the float. If the light does not come on, check the connections.
D	This green light only lights up when the robot pump is running. This green light does not light up when the pool robot has completed its cleaning cycle or during certain phases of the device's operation (e. g. after climbing walls, when pump stops and the robot sinks).
E	When the "No-Twist" float with rotating swivel is connected to the transformer and you have started the robot, this small red light indicates that the current is coming out of the float. You must have both this red light and the blue light (C) on the float. If you have the blue light on the float but not the red light, then it is likely that you will need to replace the float.

09 TROUBLESHOOTING

PROBLEM	CAUSE(S)	SOLUTION(S)
<p>The robot floats on the surface.</p>	<ul style="list-style-type: none"> - Immersion of the robot in the pool. - Use of the fine filter. - Water level in the pool. 	<ul style="list-style-type: none"> - When you put the robot in the pool, let it sink and reach the floor before you turn it on. - If you use an optional fine filter, remove the filter from its plastic wrap, immerse the filter in the water so that it is already wet before you put it in the robot and let the robot settle on the floor before you turn it on. - If your pool water level is too high, the robot might turn around and take in the air if it touches the top seats, in this case to adjust the level of the pool.
<p>The robot does not clean all areas of the pool.</p>	<ul style="list-style-type: none"> - Not enough / too much cable floating in the pool. 	<ul style="list-style-type: none"> - Make sure the length of floating cable introduced in the pool is just the required length. - Remove any excess cable length from the pool and leave this excess length outside the pool next to the power supply box. - Insert the robot at the center point of the pool. If your pool is oval or rectangular, this point is the middle of the length.
<p>The robot does not recover debris during operation. Fine particles (dust or dirt, pollen ...) are ejected by the impeller.</p>	<ul style="list-style-type: none"> - The robot does not receive enough power. - Basket clogged / full. - An object is stuck in the impeller or the grid located above the impeller. - Debris are too fine, the robot is made to pick up the particles more than 50 microns (with the fine filter inside the basket). 	<ul style="list-style-type: none"> - Check the connection of the cables. - Clean the basket and filter panels. Clean the fine filter if you use this accessory. - Check if the basket is properly inserted. (See chapter Cleaning of the filter basket). - Check that there are no foreign objects in the impeller or blocked in the grid above the impeller - Check the attachment of the basket, press it if necessary to lock it. - Use a fine filter (check item number on the parts drawing 28, sku 71170) on the other hand do not forget that it is the filtration of your swimming pool which ensures the cleaning of the particles of less than 50 microns.

PROBLEM	CAUSE(S)	SOLUTION(S)
The robot moves in one direction.	<ul style="list-style-type: none"> - An object blocks the rollers, the wheels of the robot or interfering with the movement of the robot. 	<ul style="list-style-type: none"> - Check that there are no foreign objects in the impeller located above the motor. - Check that there are no foreign object blocking the hydraulic circuit or the brushes and belts under the robot and sides.
The robot does not move and the filtration pump does not work either. The robot doesn't work any longer.	<ul style="list-style-type: none"> -The robot is not connected to a power source. - Power off. 	<ul style="list-style-type: none"> - Check that the power source is active by plugging another device into the power outlet. - Check that the power supply is turned on. - Check all connections of the robot to the power source.
The pump runs but the robot does not move. The robot turns on but stays on the spot.	<ul style="list-style-type: none"> - No / not enough power is transmitted to the robot . - An object blocks the rollers, the belts, the wheels of the robot or the path. - Possibility of motor problem. 	<ul style="list-style-type: none"> - Unplug the power and take out the robot in the water. Open the cover of the basket and remove the basket. - Check that there are no foreign objects in the impeller located above the motor. - Check that there are no foreign object blocking the hydraulic circuit or the brushes and belts under the robot and sides. - Contact the After-sales Service
Robot does not climb walls.	<ul style="list-style-type: none"> - The robot is too heavy. - The flow is not enough. - The walls are too slippery . - The handle of the robot is poorly directed. - pH level is too high. Keep the pH level close to 7.2 to avoid slippery walls. 	<ul style="list-style-type: none"> - Check that the collection of debris basket isn't full - Check and clean if need the impeller of the pump or the grid at the top of the impeller (propeller on top of the robot toward the handle) - Presence of algae on the walls or fatty deposits. Remove algae using the chemical treatment of water and manual brush to remove these fatty deposits. - Check that the handle of the robot is directed to the rear. The cable should be above the handle.
The robot goes round in circles.	<ul style="list-style-type: none"> - A belt is damaged. - one of the 4 side wheels is damaged or unscrewed. 	<ul style="list-style-type: none"> - Check the condition of the drive belts. If necessary, replace the faulty belt. - Check the wheels bolted to the ends of the rollers. These wheels fit on the roll and then screw.

PROBLEM	CAUSE(S)	SOLUTION(S)
The robot stops after a few minutes.	<ul style="list-style-type: none"> - Connection of the floating cable. - Possibility of fault of the floating cable. - Possibility of motor leakage. 	<ul style="list-style-type: none"> - Check the connection of the floating cable. Disconnect and reconnect as needed. - Check the status of the connectors at the ends of your cables (damaged, rusted, etc.)
The robot moves slower than before.	<ul style="list-style-type: none"> - The robot is too heavy. - The flow is not sufficient. - Cables connections. 	<ul style="list-style-type: none"> - Check that the dirt collecting basket is not full. - Check and clean if necessary the pump impeller or the grid above the impeller (propeller at the top of the robot towards the handle). - Check all the cable connections (see chapter 4).
No led lit on the transformer.	<ul style="list-style-type: none"> - The current is not reaching the transformer. 	<ul style="list-style-type: none"> - Check your electrical outlet. - Check the connections. - contact our Customer Service.
The blue LED on the "No-Twist" floating device does not light up (light C of Chapter 8).	<ul style="list-style-type: none"> - Bad connection between the transformer and the No-Twist floating device. - Possibility of No-Twist floating device problem - You did not press the on/off button located above the transformer. 	<ul style="list-style-type: none"> - Turn ON the cleaner by pressing the ON / OFF button located on top of the transformer. - Check all the connections of the cables between the transformer and the No-Twist floating device. - Contact the After-sales Service
The blue light on the No-Twist Floating device is on but the cleaner does not work (light C of Chapter 8).	<ul style="list-style-type: none"> - Bad connection between the No-Twist floating device and the cleaner - Possibility of No-Twist floating device problem - Possibility of motor problem. 	<ul style="list-style-type: none"> - Check if the connection at the "No-twist" float outlet, blue outlet "Pool Cleaner" is correct and waterproof. - If the blue light C is on, you should also have a red light on at the float outlet (light E in Chapter 8). If this is not the case, it is likely that the float is defective. - If both blue and red lights are on but the robot does not work, please contact your dealer or our after-sales service at info@interline-products.nl
The robot leaves traces on the floor or on the walls.	<ul style="list-style-type: none"> - State of the brushes and/or transmission belts. 	<ul style="list-style-type: none"> - These brushes and belts are wear-and-tear parts. Please check them and change them if necessary.

Please contact www.interline-products.com if you have any other questions.

10 Spare parts list

DRAWING : ITEM NUMBER	SKU	PART DESCRIPTION
1	71000	Top Shell. Dark grey
2	71010	Debris basket (parts 16, and 17 included)
3	71020	Top lid. smoke
4	71040	Impeller
5	71050	Pump motor block
6	71070	Pump cover lid. Black
7	71080	Handle
8	71090	Geared roller tube assembly . Black
9	71100	Bottom chassis. Dark grey
10	71110	Fast drain flap. Dark grey
11	71120	Left Side Support. Black
12	71130	Drive belts. Black - 2 pieces
13	71140	Geared wheel. Grey - 4 pieces
14	71150	Front roller tube.

10 Spare parts list

<i>DRAWING : ITEM NUMBER</i>	<i>SKU</i>	<i>PART DESCRIPTION</i>
15	71160	Right Side Support. Black
16	71012	Non return inlet
17	71011	Top filter screen
18	30180	Transformer
19	33291	Floating cord 13m.
20	33111	Floating cord 3m - machine end.
21	35011	Square swivel
22	36000	Power cord - UK
23	36001	Power cord - Australia
24	36002	Power cord - USA
25	36003	Power cord VDE - Europe
26	36004	Power cord - Chine
27	71180	PVC brushes set - 5 pieces
28	71170	Fine Filter pad

11 Spare parts drawing

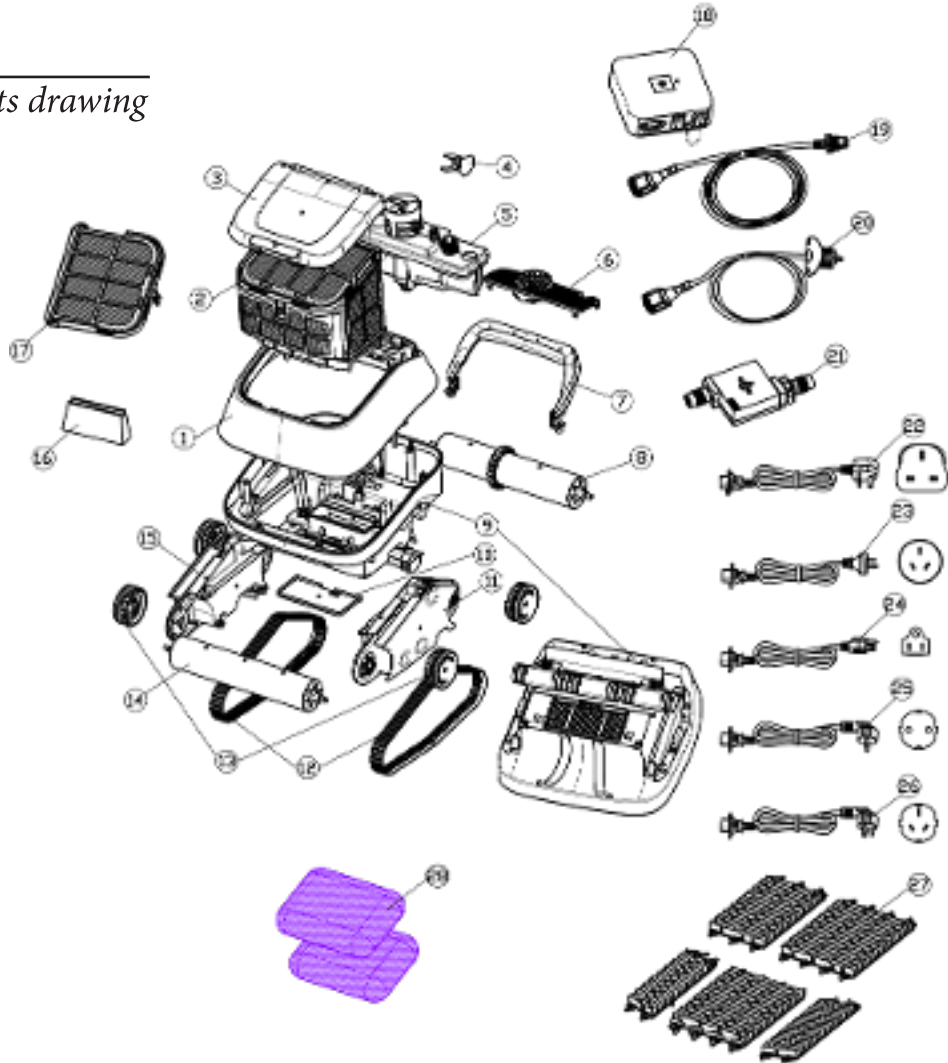

INTERLINE

